

# Upgrades of the ESSnuSB design required to enable tests of the Muon Collider Proton Complex

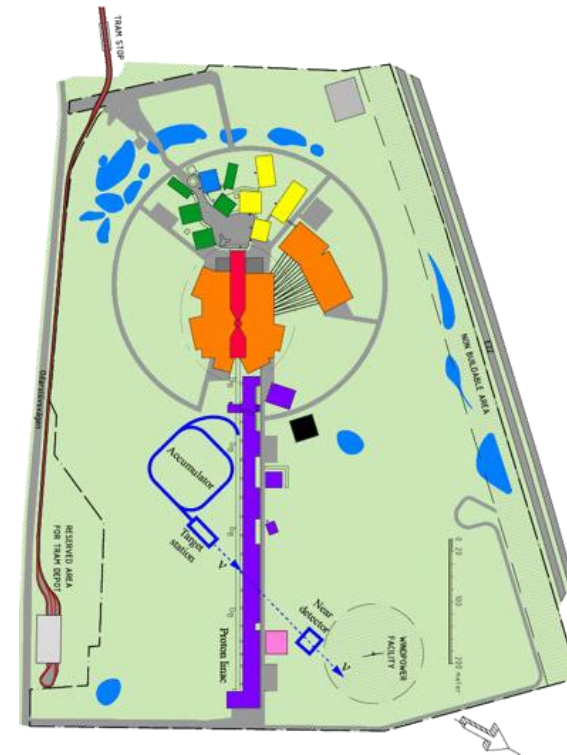

# The Muon Collider Proton Complex

The Muon Collider proton complex and the target with pion collector is one of the critical parts of the Muon Collider project because of the combination of very high power, order 2 MW, to be delivered in 5 pulses per second, each pulse being of about 2 ns length and each containing  $5 \times 10^{14}$  protons of 5 GeV.

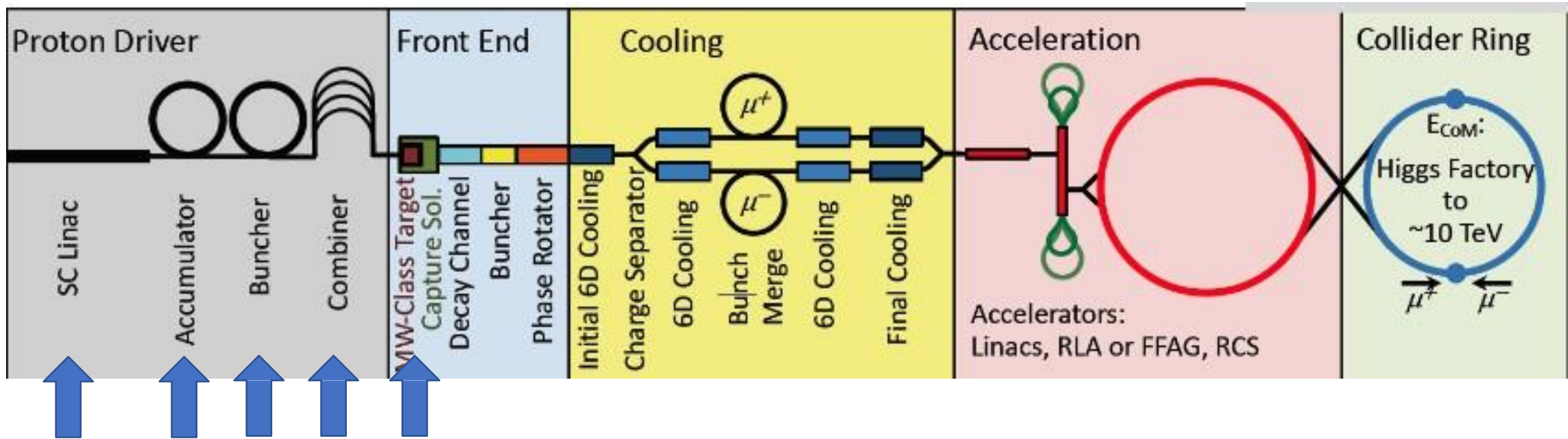

Given the ESS proton linac under construction and the ESSnuSB design already made of the linac upgrade and of an accumulator ring, it is proposed to enlarge the scope of the current design study of the linac and the accumulator and adding a design study of a compressor/buncher ring generating 2 ns bunches of order  $10^{14}$ - $10^{15}$  protons and of a target and capturing system (horn or solenoid) that can stand such bunches.

# A Neutrino Factory proton complex based on the SPL

A study was made in 2013 of the design and lay-out of the accumulator and compressor rings for a Neutrino Factory based on the use of the then planned CERN Super Proton Linac SPL project with the linac design parameters 5 GeV, 4 MW, 50 Hz and  $10^{14}$  protons per pulse.

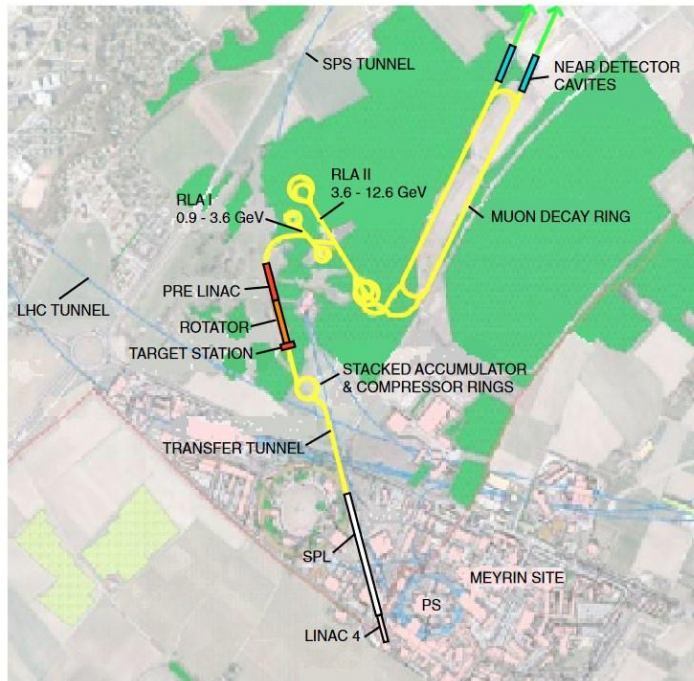

TABLE II. Parameters of the accumulator and compressor rings for the CERN proton-driver scenario.

Parameter	Value
Accumulator ring	
Circumference	185 m
No. of turns for accumulation	640
Working point (H/V)	7.37/5.77
Total bunch length	120 ns
rms momentum spread	$0.863 \times 10^{-3}$
Compressor ring	
Circumference	200 m
No. of turns for compression	86
rf voltage	1.7 MV
Gamma transition	2.83
Working point	4.21/2.74

Proton driver scenarios at CERN and Rutherford Appleton Laboratory

J. W. G. Thomason, R. Garoby, S. Gilardoni, L. J. Jenner, J. Pasternak

PHYSICAL REVIEW SPECIAL TOPICS - ACCELERATORS AND BEAMS16, 054801 (2013)



# A Neutrino Factory proton complex based on the SPL

## CERN SPL with Accumulator and Compressor Rings

From  
C. Carli  
'Proton Driver  
considerations'  
at  
Muon Collider –  
Preparatory Meeting,  
CERN, 11<sup>th</sup> April 2019

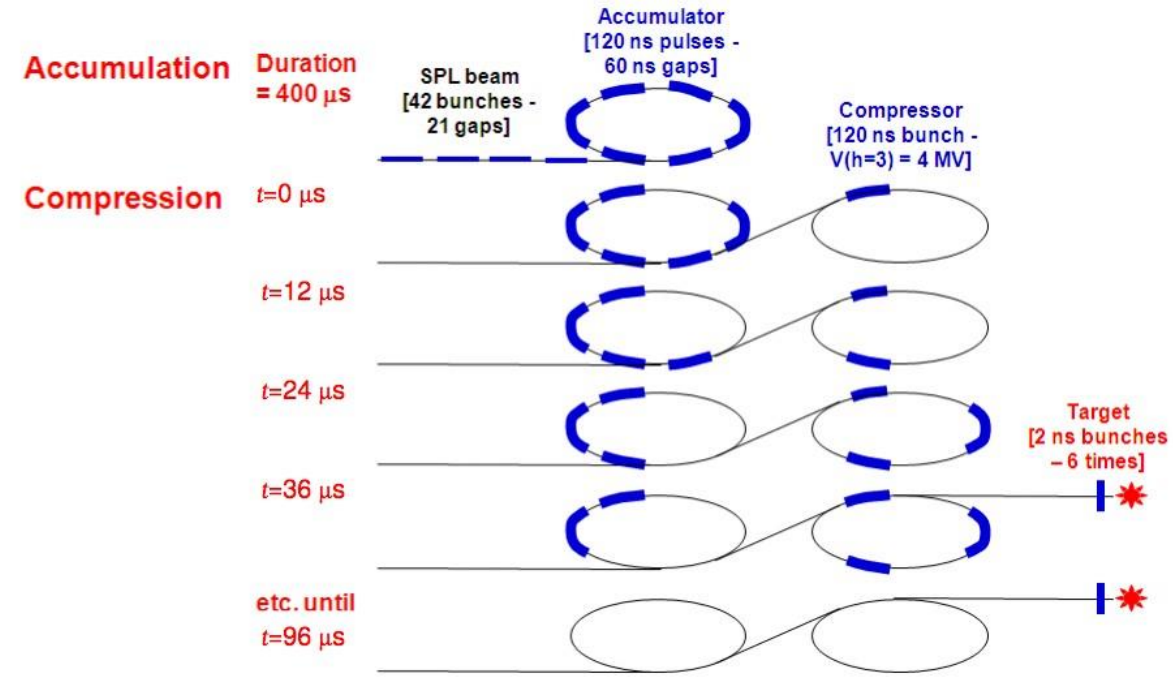
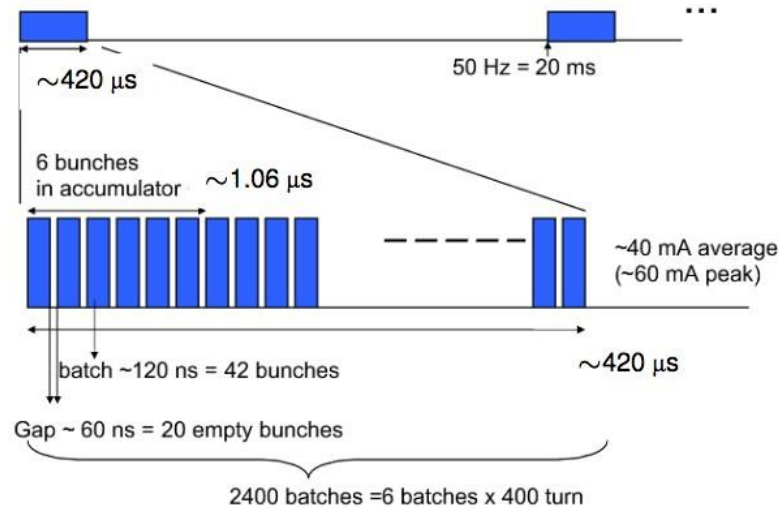

- Isochronous accumulator ring
  - No RF needed, longitudinal space charge impedance not an issue (energy change of head and tail of bunch acceptable)
  - Detailed simulations on bunch compression: final rms bunch length of 2 ns
- Compressor ring slightly shorter than accumulator to generate time structure for neutrino factory (irrelevant for muon collider)
- Some investigations on transvers and longitudinal impedances and instabilities
  - Scheme feasible at least for the short durations the beam stays in the rings

From PRSTAB 16,054801  
and CERN-2014-007

# The ESS linac

The ESS linac, currently under construction in Lund in Sweden, has as design parameters 2 GeV, 5 MW, 14 Hz and  $10^{15}$  protons per pulse, which are similar to those of the SPL and also of the current design parameters for the Muon Collider.

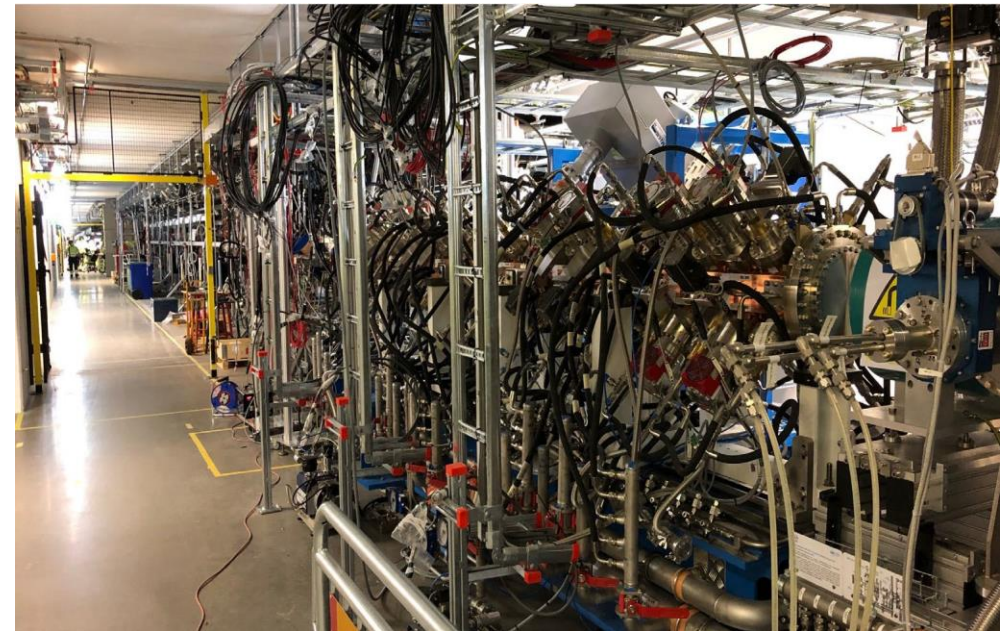
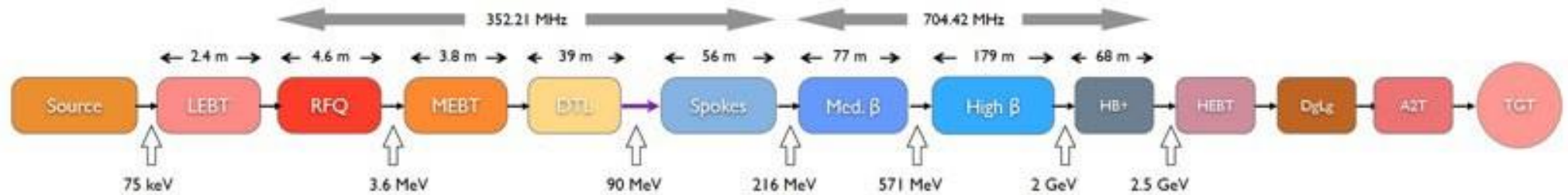

# The ESSnuSB Collaboration and the ESS linac upgrade

The ESSnuSB collaboration consisting of 15 laboratories in 11 European countries are since 2018 performing an EU supported Horizon 2020 Design Study of the increase of the ESS linac pulse frequency to 28 Hz by adding 14 H<sup>-</sup> pulses interlaced with the proton pulses, each H<sup>-</sup> pulse being chopped into 4 separate bunches, with the aim of using the H<sup>-</sup> bunches to generate a uniquely intense neutrino super-beam. The proton pulses will be used for neutron production through spallation as foreseen for the ESS baseline project.

List of ESSnuSB Participating Institutions / Organisations

#	Institutions / organisations name	Acronym	Country
1	Centre National de la Recherche Scientifique	CNRS	France
2	University of Uppsala	UU	Sweden
3	Kungliga Tekniska Hoegskolan	KTH	Sweden
4	European Spallation Source Eric	ESS	Sweden
5	University of Cukurova	CU	Turkey
6	Universidad Autonoma de Madrid	UAD	Spain
7	National Center for Scientific Research "Demokritos"	DEMOKRITOS	Greece
8	Instituto Nazionale di Fisica Nucleare	INFN	Italy
9	Ruder Boskovi Instgitute	RBI	Croatia
10	Sofiiski Universitet Sveti Kliment Ohridski	UniSofia	Bulgaria
11	Lunds Universitet	ULUND	Sweden
12	Akademia Gorniczo-Hutnicza Im. Stanislaw Staszica w Krakowie	AGH / AGH-UST	Poland
13	European Organization for Nuclear Resarch	CERN	Switzerland
14	University of Geneva	UNIGE	Switzerland
15	University of Durham	UDUR	United Kingdom

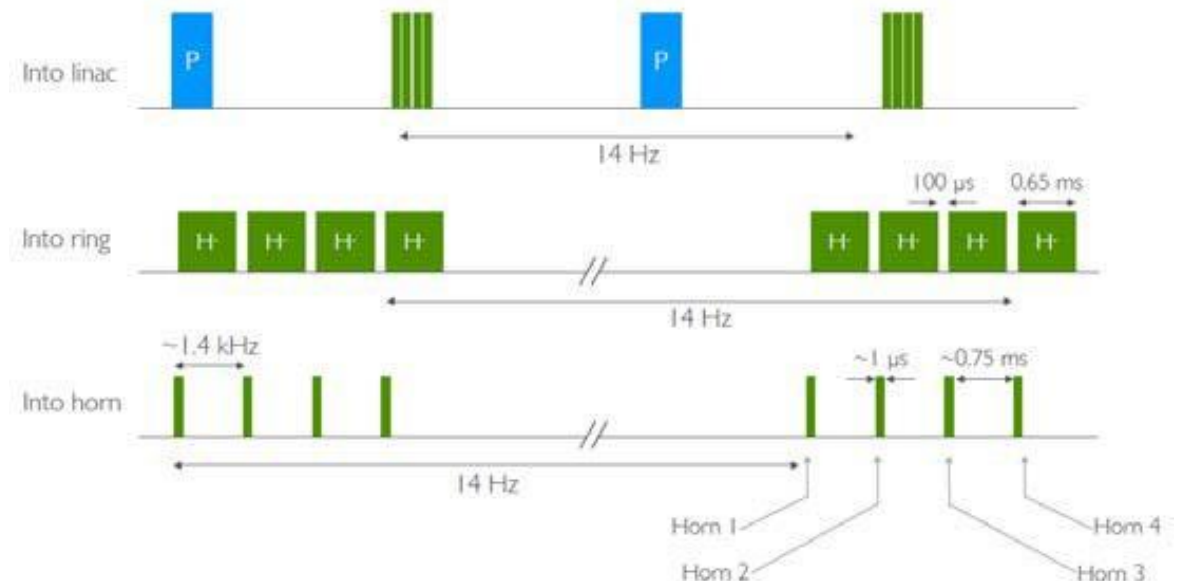



# The ESSnuSB Accumulator Ring and Target Station

The EU design study includes an accumulator ring, into which the 4 chopped H<sup>-</sup> pulses shall be injected in sequence. Each of the four 1.3  $\mu$ s proton bunches of  $2.5 \times 10^{14}$  protons extracted in sequence from the accumulator shall be guided to one of four laterally separated granular Titanium ( $A=22$ ) He-cooled targets, each surrounded by a focussing horn. The Conceptual Design Report of this 4-years Design Study is currently being finalized and will be published in January 2022.

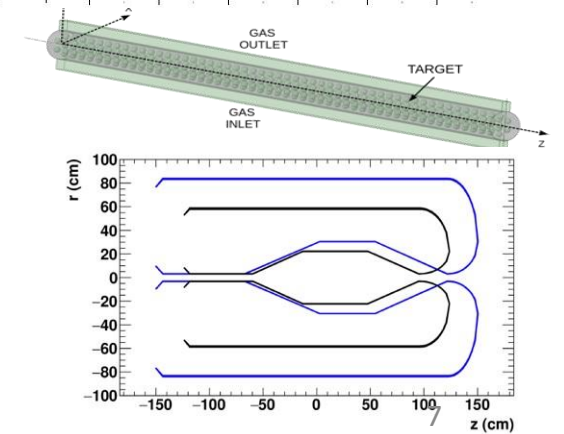
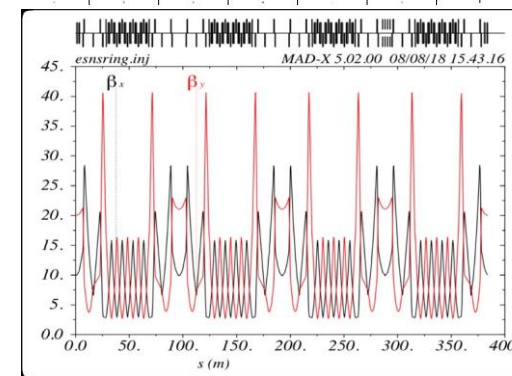
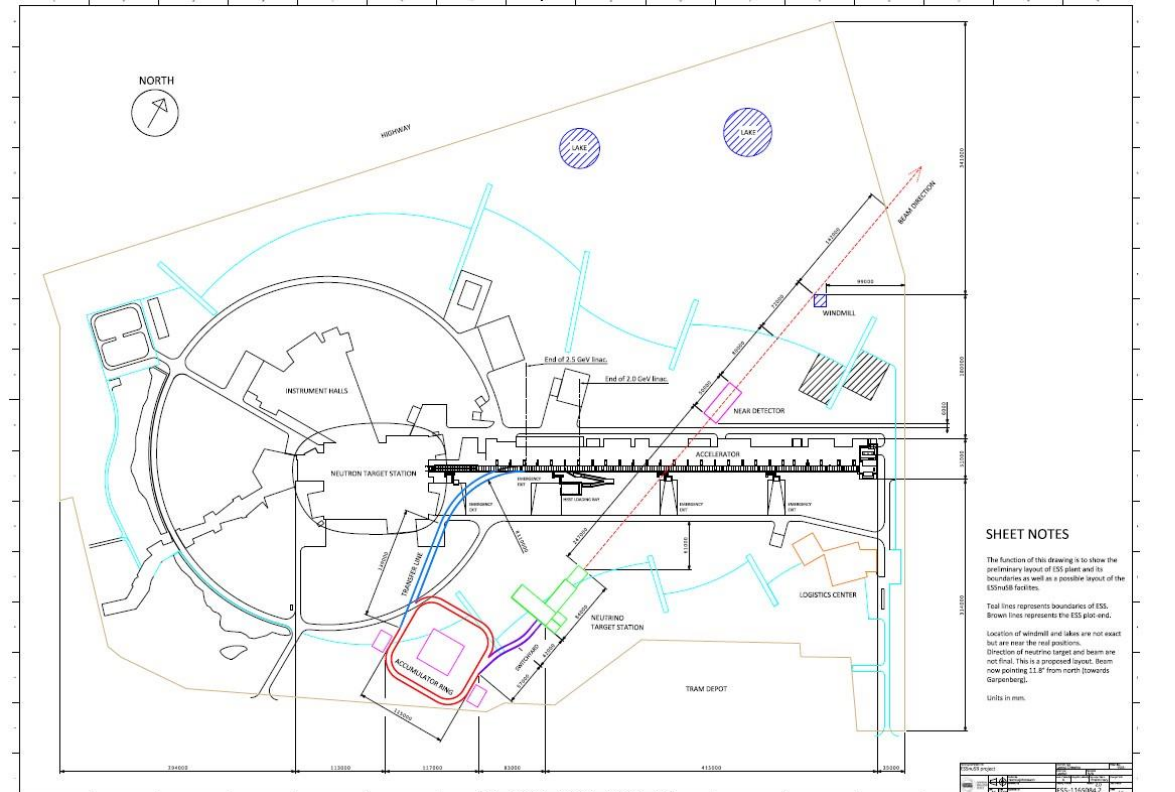

# Heavy (high A) or light (low A) target material ?

Pion yield spectrum at different proton beam energies for one and the same beam power (ref. Paola Sala / CERN)

Mercury (A=80) target

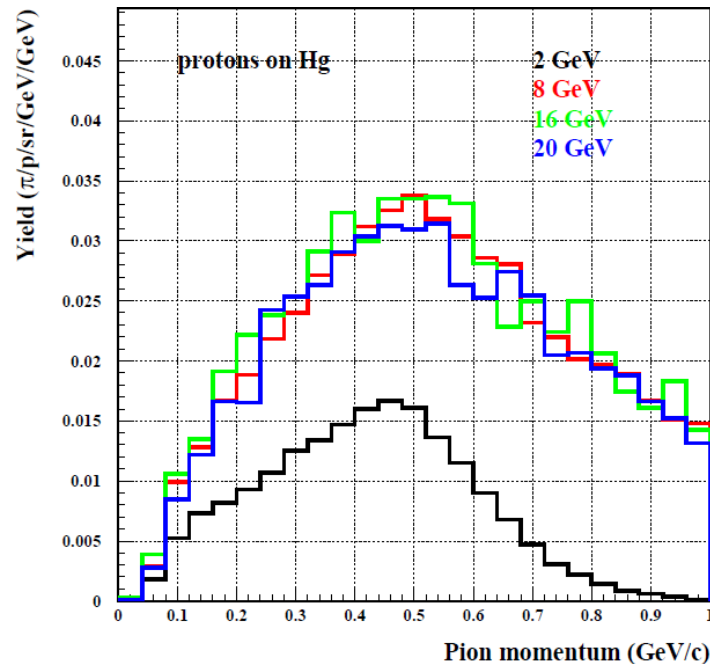

Carbon (A=13)target

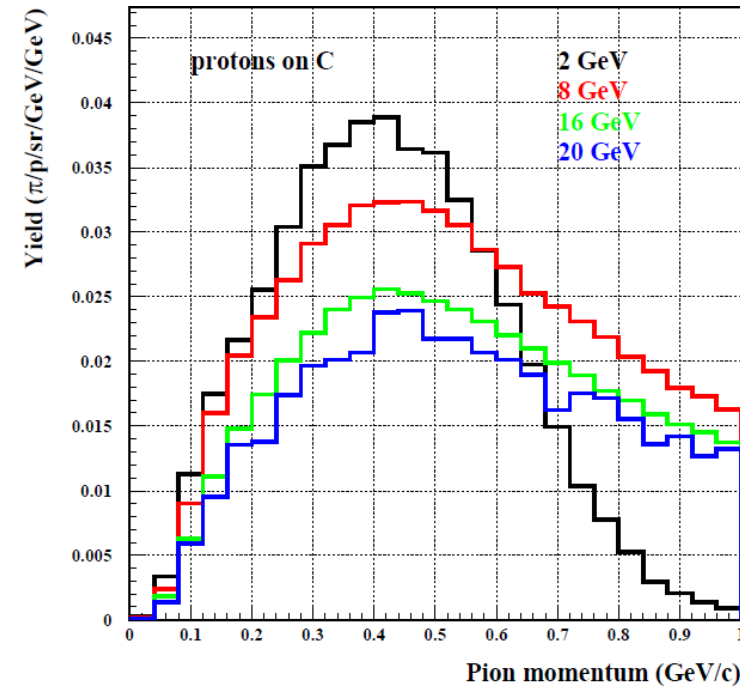



# Complementary Design Study of Muon Collider Proton-Complex Test-Facility

It is proposed that during the next period 2022-2025 of the Design Study, the study be enlarged in scope to include also how the already studied design of the upgrade of the ESS linac, the design of the accumulator ring and the design of the target station can be widened to encompass also the requirements of the Muon Collider.

This implies the conceptual study of, inter alia, an alternative chopping scheme for the linac, of the accumulator acceptance, rf system, timing and optics, of a design from scratch of a compressor/bunch rotation ring and of a separate target station with a target and capture system (horn or solenoid) that can stand the 2 ns long bunches of  $10^{15}$  protons, using the ESSnuSB  $2.5 \times 10^{14}$  protons/  $1.3 \mu\text{s}$ /1.25 MW target design as starting point. Design is stages possible, i.e. first making a  $10^{15}$  protons/ $1.3 \mu\text{s}$ /5 MW target design.

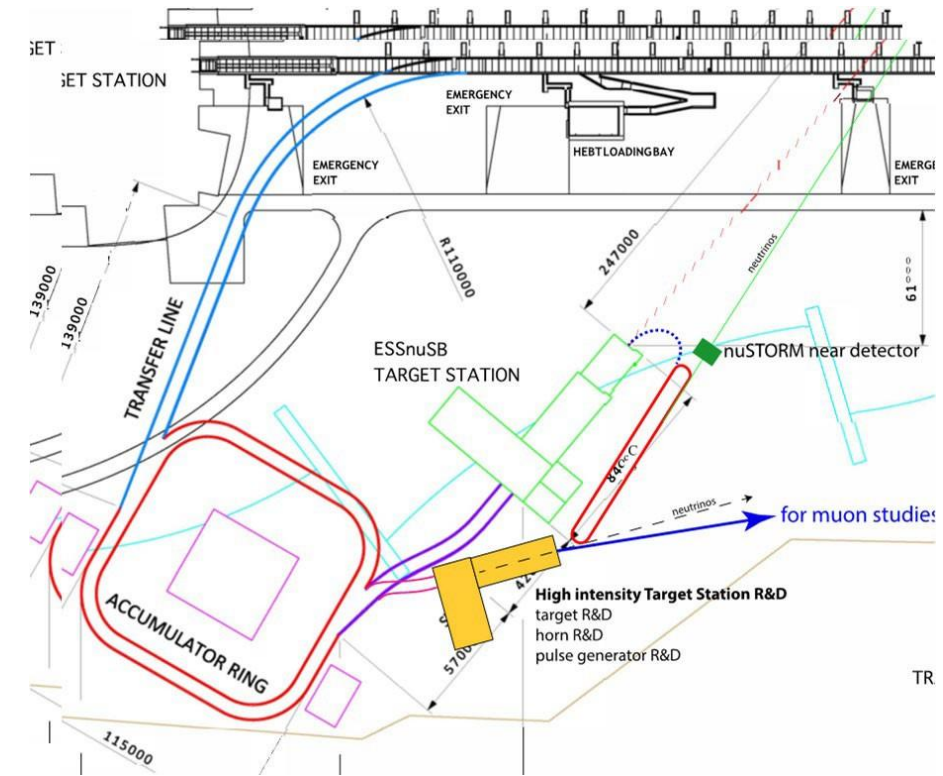

Accumulator ring to be complemented with a Compressor ring



Pion momentum distribution in a 4m x 4m aperture

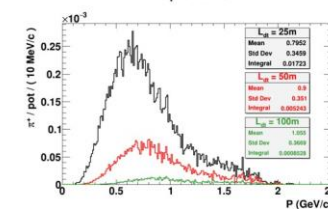

Muon momentum distribution in a 4m x 4m aperture

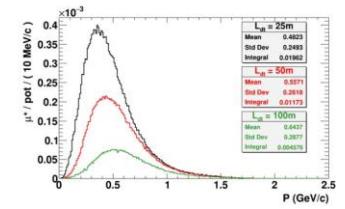

## Proton Driver Proposals

Based on ESS adding Accumulator and Compressor Rings

From  
C. Carli  
'Proton Driver  
considerations'  
at  
Muon Collider –  
Preparatory Meeting,  
CERN, 11<sup>th</sup> April 2019

From a presentation by  
C. Rubbia at  
XVIII Int. Workshop on  
Neutrino Telescopes,  
18-22 March 2019

- Rings with  $\sim 35$  m radius
- Accumulator ring filled with 14 Hz repetition rate
- Accumulator to compressor transfers with  $4 \times 14$  Hz up to 54 ms

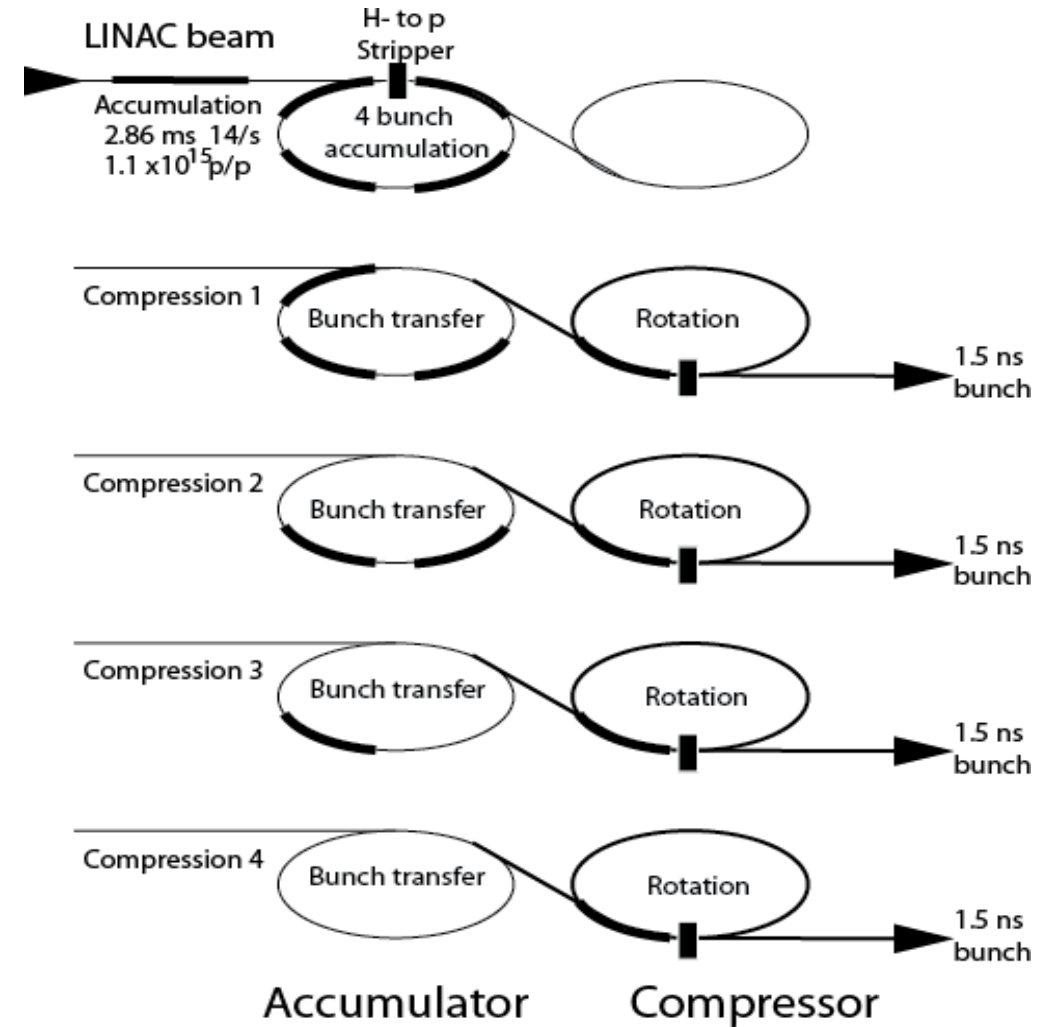

# Proposal for a EU Horizon Europe Design Study 2022-2025

We are planning to submit in Spring 2022 a proposal to EU Horizon Europe for a Design Study of features of the ESSnuSB design not yet studied during 2019-2021, like the civil engineering, licensing and safety required at the ESS and Far Detectors sites, preparation of the ESSnuSB R&D phase and a conceptual design study of a 0.5 GeV nuSTORM race track ring for low energy neutrino cross-section measurements with the aim to deliver an Technical Proposal in 2025.

The plan would be to include resources in the requested budget for a conceptual design study of the Muon Collider proton-complex test-facility described above.

**HORIZON-INFRA-2022-DEV01**

***Developing European Research Infrastructures to maintain global leadership***

**Deadline: 24 March 2022**

Topics	Type of Action	Budgets (EUR million)	Expected EU contribution per project (EUR million)	Number of projects expected to be funded
		2022		
Opening: 10 Nov 2021				
Deadline(s): 24 Mar 2022				
HORIZON-INFRA-2022-DEV-01-01	RIA	24.00	1.00 to 3.00	10
Overall budget	indicative	24.00		



# An ESSnuSB Proton Complex Test Facility for the Muon Collider



On the basis of overall design study it would then, as from 2025, be possible to discuss the option of realizing - in parallel with the ESSnuSB build-up - the ESS linac power upgrade, the accumulator and the compressor rings and the target stations which could then, in synergy with ESSnuSB, be used as a Proton-Complex Test-Facility for the Muon Collider in the first half of the 2030's.

Lund, May 25<sup>th</sup> 2021

Dear Tord,

I was very pleased to hear of the progress that you have made with the ESSnuSB design study and I look forward to reading the Conceptual Design Report (CDR) in due course. The second phase of your work is very innovative and deserves to be supported. It broadens considerably the scientific scope and impact of the proposed upgrade to the ESS linear accelerator (linac). I encourage you to put the considerable energies and expertise of your collaboration into this second phase.

On behalf of the ESS organisation I would like to reiterate our continued strong support for the neutrino and muon physics opportunities presented by the ESSnuSB initiative as previously communicated by John Womersley in 2017.

Please keep me posted on the outcome of the upcoming TIARA meeting and your further progress.

With best regards

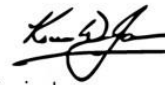

Kevin Jones  
Acting Director General

*This letter was sent with Cc to Helmut Schober, ESS DG as from 1 Nov 2021, and Mats Lindroos, Leader of the ESS Linac Division.*

# Conclusions I

- The Proton Complex is one of the critical parts of the Muon Collider project
- A study of a Muon Collider Proton Complex based on the use a CERN 4 MW Super Proton Linac (SPL) was made in 2013
- The 5 MW ESS proton , now under construction, is similar in several respects to the SPL design that was made
- Since 2018 is carried out an EU supported Design Study of a uniquely intense neutrino-beam complex based on the ESS linac, which will result in January 2022 in a Conceptual Design Report

## Conclusions II

- It is proposed to enlarge in 2022-2025 the scope of the ESSnuSB design of the linac and the accumulator and to make a design of a compressor/buncher ring generating 2 ns bunches of order  $10^{14}$ - $10^{15}$  protons and of a target and focusing horn that can stand such bunches, with the aim to fit the requirements of a Muon Collider Proton Complex
- A Conceptual Design Report of this complementary design study would be ready by 2025 and could serve as a basis for the discussion of the realization of an ESS based Muon Collider Proto-Complex Test-Facility to be operational in the first half of the 2030's.
- The ESS Proton Complex could also possibly come to serve as the first stage of a facility to test muon cooling at full intensity - until CERN has taken the decision to build an SPL for a 3, 10 or 14 TeV Energy Muon Collider, allowing such tests to be made at CERN - and, in an maybe even longer perspective, as the proton complex of a 125 GeV Muon Collider Higgs Factory at ESS that you will hear about from Carlo Rubbia in his talk following now.



# A few back up slides

# The ESS linac components being assembled and tested

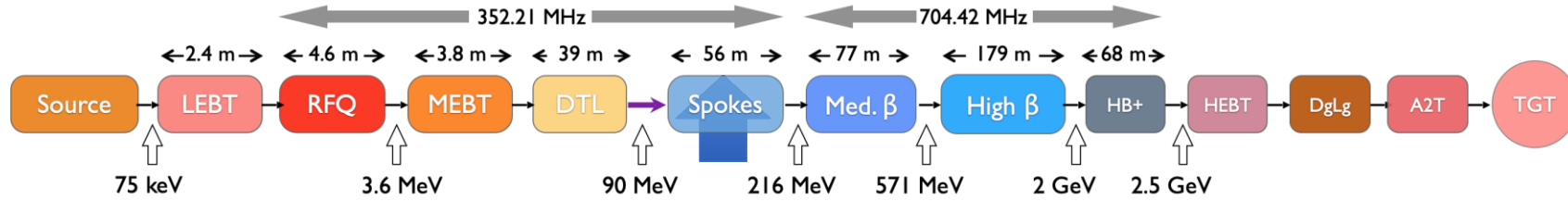

ESS 8 October 2020

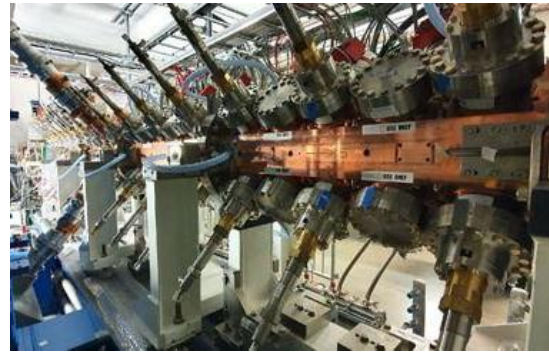

RFQ



Spoke CM proto in FREIA



MEBT



DTL



Fists spoke CM 18 Oct 2020

# ESSvSB schedule a 2<sup>nd</sup> generation neutrino Super Beam

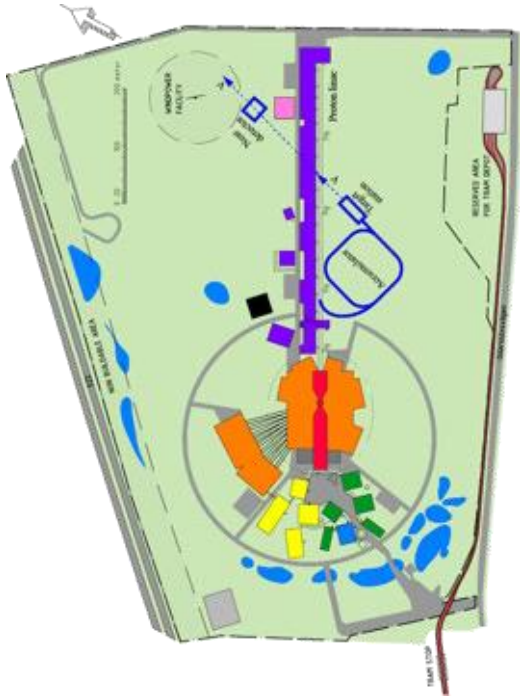

**2012:**  
inception of  
the project

*Nucl. Phys. B 885  
(2014) 127*



**2016-2019:**  
beginning of  
COST  
Action  
EuroNuNet



**2018:**  
beginning of  
ESSvSB  
Design  
Study (EU-  
H2020)

**2021:** End of  
ESSvSB  
Design Study,  
CDR and  
preliminary  
costing



**2022-2024:**  
Preparatory  
Phase, TDR

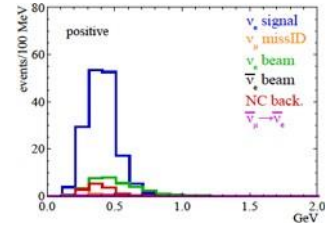
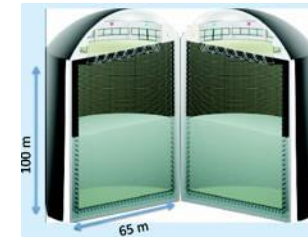

**2035-:**  
Data  
taking

**2027-2034:**  
Construction of  
the facility and  
detectors,  
including  
commissioning

**2025-2026:**  
Preconstructi  
on Phase,  
International  
Agreement

